

Environmental and Performance Impact of Jatropha Biodiesel Blends on Combustion in Compression Ignition Engine

S.I. Hawash, K.M. El-Khatib and G. El Diwani*

Abstract- In this study, extracted oil from jatropha seeds was used to produce neat (pure) biodiesel through transesterification, and this converted biodiesel was used to prepare biodiesel/diesel blends. This study presents the preliminary research results of an investigation carried out on the potentiality of different biodiesel blends as an alternative fuel for compression ignition engines at load and no load conditions. The main objective of this research is to compare selected emissions of petroleum diesel with jatropha biodiesel fuel blends (B10, B20, B30, and B100) and B10* treated by ozonation. B20 produced the lowest CO concentration for engine test. B50 produced higher CO₂ than other fuels for all engine tests, where B20 gave the highest. The biodiesel and biodiesel/diesel blend fuels produced higher NO_x for various engine tests as expected. SO₂ formation showed an increasing trend as the percentage of diesel increased in the fuels. Overall, we may conclude that B20 is the optimum fuel blends. of adsorbent or temperature .

Key words: Biodiesel, C.I. engine, engine testing, emissions, engine performance..

1. Introduction

Due to gradual depletion of world petroleum reserves and the impact of environmental pollution due to increasing exhaust emissions, there is an urgent need for suitable alternative fuels to use in diesel engines. In view of this, vegetable oil is a promising alternative because it has several advantages, it is renewable, environ- friendly and produced easily in rural areas, where there is an acute need for modern forms of energy [1-7].

Growing concern regarding energy resources and the environment has increased interest in the study of alternative sources of energy. Biodiesel is a very attractive alternative fuel, which is successfully used for some time in different blends with gasoline in spark compression ignition engines (C.I.). Biodiesel can be blended and used in many different concentrations, including B100 (Pure biodiesel), B20 (20% biodiesel, 80% petroleum diesel), B5 (5% biodiesel, 95% petroleum diesel) and B2 (2% biodiesel, 98% petroleum diesel). B20 is common biodiesel blend in the united state. Biodiesel blend can be used in C.I. with little or no modifications. Biodiesel has some technical benefits such as its blend with petroleum diesel reduced the wear of aluminum, iron, chromium and lead components in a diesel engine. Also biodiesel improves lubricity, increases cetane number, has higher flash point and gives the same engine performance as petroleum diesel.

Therefore, in recent years systematic efforts have been made by several research workers to use vegetable oils as fuel in engines [8-11]. Obviously, the use of non- edible vegetable oils compared to edible oils is very significant because of the tremendous demand for edible oils as food and they are far too expensive to be used as fuel at present.

From previous studies [12-14] it is evident that there are various problems associated with vegetable oils being used as fuel in compression ignition (C.I.) engines, mainly caused by their high viscosity.

Due to high viscosity, in long term operation, vegetable oils morally introduce the development of gumming, the formation of injector deposits, ring sticking, as well as incompatibility with conventional lubricating oil [14-18]. Therefore, reduction in viscosity is of prime importance to make vegetable oils a suitable alternative fuel for diesel engines.

Biodiesel derived from vegetable non edible oils, is the most promising alternative fuel to conventional diesel (derived from fossil fuels), due to the following reasons [19].

- Biodiesel can be used in existing engines without any modifications.
- Biodiesel is made entirely from vegetable sources; it does not contain any sulfur, aromatic hydrocarbons, metals or crude oil residues.
- Biodiesel is an oxygenated fuel; emissions of carbon monoxide and particulates end to be reduced compared to conventional diesel fuel.

Chemical Engineering and Pilot Plant Department National Research Centre, Dokki Giza, Egypt
*Co-Author E-mail: geldiwany@yahoo.com

- Unlike fossil fuels, the use of biodiesel does not contribute to global warming as CO₂ emitted is once again absorbed by the plants grown for vegetable oil/ biodiesel production. Thus CO₂ balance is maintained.
- The Occupational Safety and Health Administration classify biodiesel as a non-flammable liquid.
- The use of biodiesel can extend the life of diesel engines because it is more lubricating than petroleum diesel fuel.
- Biodiesel is produced from renewable vegetable oils/animal fats and hence improves fuel or energy security and economy independence.

The rising oil prices, ecology aspects, the desire to increase energy self-sufficiency and create employment are motivating the countries around the world in support of biofuels research and production. The most widely studied renewable motor fuels for compression ignition engines in the recent years are biodiesel and ethanol [20]. Diesel-powered compression ignited engines contribute large amounts of sub-micron particulate matter to the environment and have been shown to contribute to atmospheric greenhouse gases and deleterious health effects.

Biodiesel is a proposed alternative biofuel produced through transesterification, a process in which organically derived oils combine with a methyl [21] or ethyl alcohol in the presence of catalyst [22] to form ethyl or methyl ester. Biodiesel is an environmentally sustainable fuel that does not contain sulfur or aromatics and may decrease the overall detrimental effects of diesel powered engines [23].

The valorization of biodiesel by an efficient use in transportation sector, will bring great benefits for the environment and the local population, job creation provision of modern energy carriers to rural communities, avoidance of urban migration, and the reduction of CO₂ and sulfur levels in the atmosphere [24]. However, methyl esters of animal and vegetable oils (biodiesel), due to their cleaner burning tendencies in the compression ignition engine, are again being evaluated for use as a fuel for modern diesel [25].

The purpose of this study was to analyze and draw comparisons concerning the fueling of (BEC) Bharti Diesel Engines with one cylinder, four stroke and water cooled.

2. Materials and Methods

2.1. Biodiesel production

A batch of biodiesel was produced from Egyptian Jatropha oil at pilot scale in chemical Engineering and pilot plant Department, National Research Centre. The biodiesel (FAME) is produced in a batch, stirred tank reactor. Alcohol to triglyceride molar ratio is 6:1; the reactor is sealed and equipped with a reflux condenser. Operating temperature is about 65°C for one hour. The most commonly used catalyst is sodium hydroxide at loading range 1% by weight of oil. Thorough mixing is necessary at the beginning of the reaction; less mixing can help increase the extent of reaction by allowing the inhibitory product, glycerol, to phase separation from the ester-oil phase. Completions of 85% to 94% reaction are reported [26].

Characteristics of biodiesel produced and tested in the engine are illustrated in Table (1) compared with #2 diesel and test methods used. Stabilized Biodiesel was also produced through ozonation of the Jatropha biodiesel by bubbling ozone gas at a dose of 40 g O₃/m³ at a rate of 0.5 L/min. After complete ozonation, nitrogen gas is purged into the ozonated oil to get rid of the un reacted ozone. Ozonated vegetable oils were added (1% by weight) and stirred thoroughly for well mixing with biodiesel at 40°C using water bath.

2.2. Biodiesel mechanical testing

Biodiesel testing was carried out on a BEC type engine "Bharti Diesel Engines" testing. The engine has one cylinder, four stroke and water cooled [27].

2.2.1. Measured values:

2.2.1.1 Fuel consumption

A 2.5 inch pipe with external guide and scale which connected to the engine tank is used to measure the height of the fuel consumed ($\Delta H = H_2 - H_1$) which is illustrated in Figure (1).

2.2.1.1. Power

Pump pressures difference

The engine power value is measured using two items:

- The pressure difference between the inlet and exit of the pump ($P_{del} - P_{suc}$)
- Water flow rate (Q) by orifice pressure drop (ΔP).

Table (1) Comparison between #2 Diesel and Biodiesel Standards

Properties (Units)	Standard Range		Biodiesel produced	Test Method
	#2 Diesel	Biodiesel		
Iodine Value(Cg I ₂ /g)	110 max	102	DIN 53241 or IP84/81
Cetane Number	51	45 min	51	ASTM D613
Flash Point (°C)	54-71	100 (min)	191	ASTM D93
Pour Point (°C)	(-35) – (-15)	(-15) – (16)	-15	ASTM D 97
Cloud Point (°C)	(-15) – -5	(-3) – 12	ASTM D5773
Heating Value (MJ/kg)	ASTM D240
	• Higher	44.3	40.5	
	• Lower	41.55	37.1
Melting Point (°C)	(-30) – (-18)	N/A	N/A	N/A
Carbon Residue %weight	0.2 max	0.3 max	0.02	ASTM D5450
Sulfur Content %weight	< (.0 - 1.2)	0.01max	0.01	ASTM D5453
Viscosity@ 40 °C (mm ² /s)	1.9 – 4.1	1.9 -6.0	4.84	ASTM D445
Water Content (mg/kg)	200 max	500 max	460	ASTM D1442
Boiling Point (°C)	188 - 343	182 – 338	295	N/A
Particulate Matter(mg/kg)	N/A	15	N/A	DIN 51419
Self Ignition (°C)	254 - 285	N/A	N/A	ASTM D1929
Gum Content (mg/100mL)	13.2	N/A	N/A	ASTM D381
Acid Value (mg Na OH/g)	0.5 max	0.24	ASTM D664
Density@15°C (kg/m ³)	820 - 845	860-900	879	ASTM D1298

The pump pressures difference was measured using two pressure gauges:

- Vacuum gauge pressure that has a limit of (-1 to 1 bar) at the inlet of the pump which have a negative value.
- Pressure Gauge (0-6) bars at the exits of the pump which has a positive value.

At the exit pressure, a mercury nanometer is used instead of the gauge pressure due to the low value of pressure that was under the atmospheric pressure.

Water flow rate

The water flow rate is measured using the orifice area and the pressure drop through it.

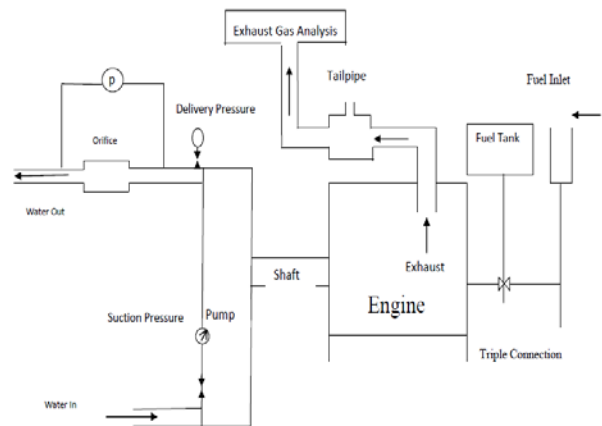

Figure 1: Scheme of Testing Engine

Exhaust Gas Analyzing

The experimental procedure was performed using biodiesel and its blends in the engine at loaded engine (pump connected) and unloaded engine (without pump). The used fuels in the experiments were:

- B0 (pure #2 Diesel).
- B10 (10 volume %).
- B20 (20 volume %).
- B30 (30 volume %).
- B10* with ozonation (10 %volume ozonized biodiesel, 90% diesel).
- B100 (pure biodiesel).

3. Results and Discussion

The experimental techniques and environmental results of using biodiesel and its blends in the engine have been demonstrated in percent relative to diesel.

3.1. Loaded and unloaded Engine Results

3.1.1. Effect of biodiesel on engine performance

Thermal efficiency is the indication of efficiency with which the chemical energy input in the form of fuel is converted into useful work. Using different blends of biodiesel with # 2 diesel (B0 to B100), the engine performance is observed to be approximately constant for all blends. This result is because biodiesel blends viscosity is approximated to that of diesel which is in good agreement with previous studies [28-33]. Small numbers of studies, however, have reported some improvement in thermal efficiency when using biodiesel fuel [34-35].

3.1.2. Fuel consumption

Brake-specific fuel consumption (BSFC) is the ratio between mass consumption (mf) and brake effective power, and for a given fuel it is inversely proportional to thermal efficiency. Figure (2) illustrates the relation between percent change in fuel consumption and the heating value at load and no load conditions, from which it is clear that increasing biodiesel in the blend increase fuel consumption due to the decreasing of heating value of biodiesel comparing to diesel in case of load conditions. While the fuel consumption in un load conditions with a rate less than that in loaded engine. These results are in good agreement with previous investigations [36].

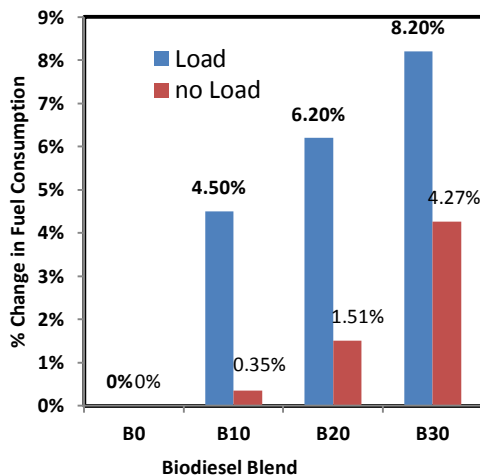

Figure 2: Percent Change in Fuel Consumption

3.1.3. Nitrogen Oxides (NO_x) Emissions

Figure (3) shows the variations of NO_x emissions with respected to engine at load and no load conditions. NO_x emissions of biodiesel and its blends are higher than those of diesel fuel. The difference of NO_x emission between diesel fuel and biodiesel and its blends reach high percent change. Approximately 624.29% increase in NO_x emission was realized in case of using pure biodiesel (B100), while reach 4.29% in case of using B20. It has also been reported by Zheng et al. [37] that the biodiesel with a cetane number similar to the diesel fuel produced higher NO_x emissions than the diesel fuel. Consequently, a weaker mixture would be generated and burnt during the premixed burning phase resulting in relatively reduced NO_x formation. Investigations revealed that NO_x emissions increase with an increase in the biodiesel content of diesel which is due to higher content of nitrogen in biodiesel. In recent engines this fact can be controlled

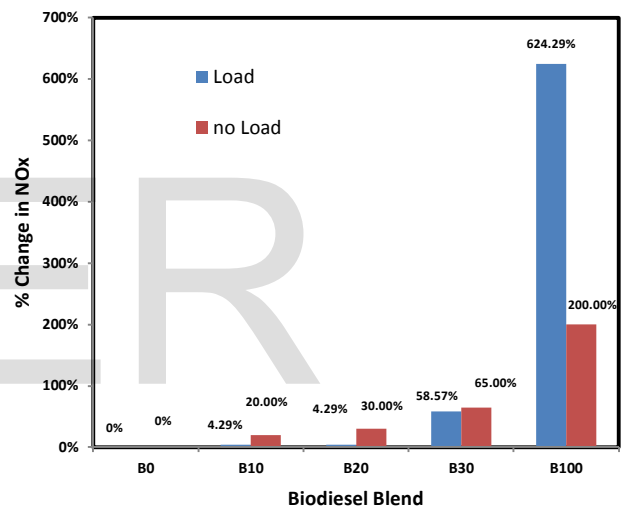

Figure 3: Percent Change in NO_x

3.1.4. Carbon Monoxide (CO) Emissions

When substituting diesel fuel with biodiesel blend, a decrease in CO emissions which agreed with previous studies [38-39] and the authors have explained this to better combustion in biodiesel fueled engines. Since biodiesel is an oxygenated fuel, it promotes combustion and results in reduction in CO emissions. CO emissions from unloaded engine is decreased by increasing biodiesel in biodiesel blend as shown in Figure (4), same as it in loaded engine. Fig. 4 shows the variations of CO emissions with respect to engine load and no load. The differences between the CO emissions of biodiesel and its blends with diesel fuel are fairly small. At engine load, the CO emissions of biodiesel and its blends are evidently lower than those of diesel fuel. The CO emission of diesel fuel is 0.09%, but those of

biodiesel and its blends are less than 0.05% at engine load. This may be due to more oxygen content of biodiesel compared with diesel fuel. In addition, it is likely that this is because the biodiesel has C/H ratio that is less than for diesel fuel [15]. However, the amount of decrease in CO emissions does not depend on biodiesel percentage in the blends. Last et al. [16] also reported that a decrease in CO emissions can be observed when using biodiesel and its blends with diesel fuel but trend in reduction is not linear [17].

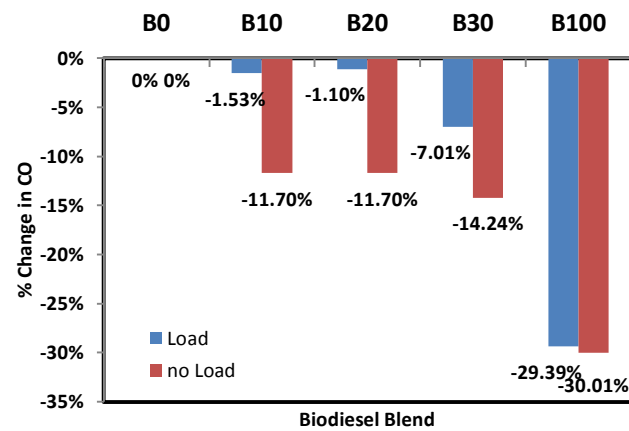

Figure 4: Percent Change in CO Emissions

3.1.5. Sulfur Dioxide (SO₂) emissions

Sulfur dioxide (SO₂) emissions decrease with the increase of the blend percentage as shown in Figure (5) because biodiesel is sulfur free. This result is in good agreement with previous investigation which found that 2% blend biodiesel reduced acid rain causing sulfur dioxide emissions and B100 exhaust contained no benzene, sulfur or formaldehyde and reduced greenhouse gases by nearly 80% as compared to petroleum diesel [39].

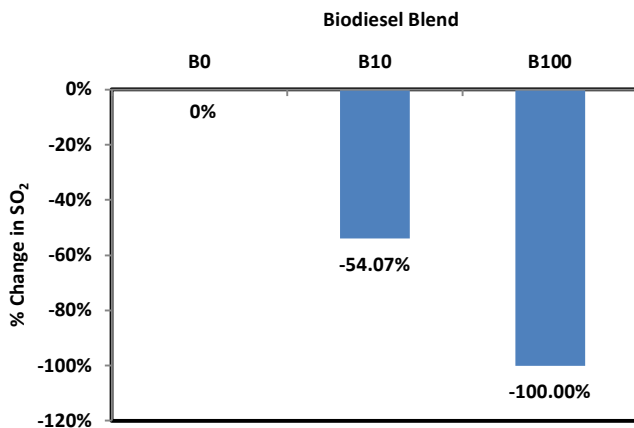

Figure 5: Percent Change in SO₂ Emissions

3.3. Comparison between ozonized (B10*) and non ozonized (B10) biodiesel compared to #2 diesel in no load engine.

The physico-chemical characteristics of biodiesel treated with ozone showed improvement of pour point and flash point indicating higher degree of safety for fuel [39]. The oxygen content of biodiesel samples treated with ozone increased weight % and resulted in more extensive chemical reaction, promoted combustion characteristics and less carbon residue was produced [40]. Figures (6 & 7) illustrates the results of B10 and B10* emissions for loaded and unloaded engine. Comparison between B10 and B10* emissions are observed in the following:-

- Fuel Consumption: B10* is less than B10.
- SO₂ Emissions: B10* and B10 are the same.
- NOx Emissions: B10* is less than B10
- CO Emissions: B10* is less than B10

It can be concluded that ozonation of the biodiesel improving its properties.

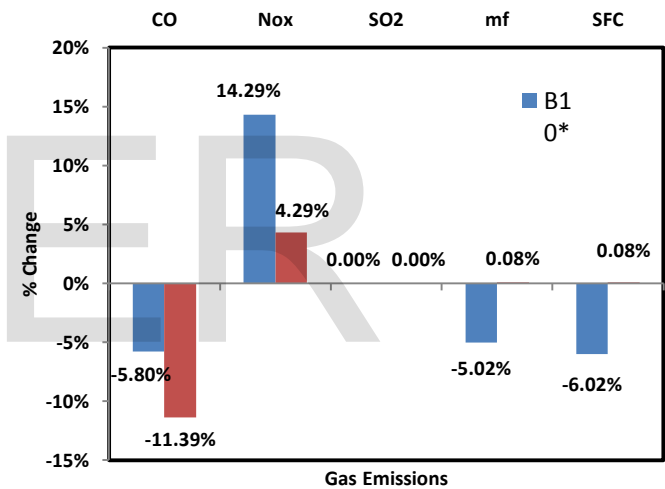

Figure 6: B10 & B10* under (No Load) in Gas Emissions

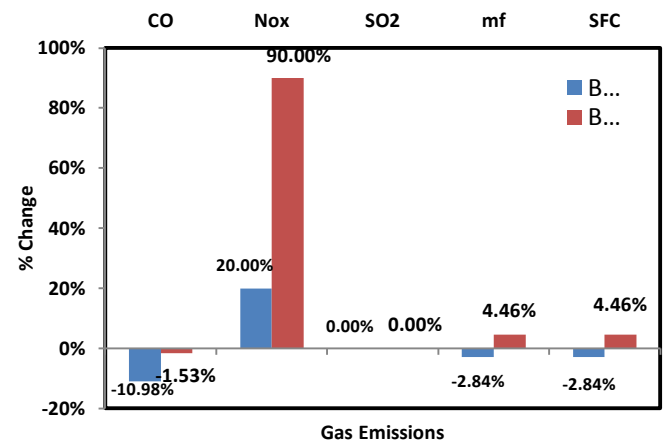

Figure 7: B10 & B10* under (Load) in Gas Emissions

4. CONCLUSIONS

1. B20 and lower-level blends generally do not require engine modifications. Engine operating on B20 have similar fuel consumption to engines running on petroleum diesel.
2. B20 has a higher cetane number (a measure of the ignition value of diesel fuel), higher flash point than petroleum diesel (less flammable, more safe) and higher lubricity (the ability to lubricate fuel pumps and fuel injectors) than petroleum diesel.
3. Biodiesel contains about 8% less energy per gallon than petroleum diesel. For B20, this could mean 1% to 2% difference, but most B20 users report no noticeable difference in performance of fuel economy.
4. Green house gas and air quality benefits to biodiesel are roughly commensurate with the blends. B20 use provides about 20% of the benefit of B100 use.
5. Biodiesel reduces global warming gas emissions such as reduction in CO₂ emissions.
6. Biodiesel reduces tailpipe particulate matter, hydrocarbon and carbon monoxide emissions from most modern four-stroke compression ignition engines.
7. Safety – Health effects tests confirm biodiesel is ten times less toxic than table salt and biodegradable as fast as sugar.
8. Replacing diesel fuel with biodiesel reduced the wear of aluminum, iron, chromium and lead components in a diesel engine.
9. Added to the decrease in the environmental pollution, the economical benefits of biodiesel are that it displaces imported petroleum diesel and creates economic employment opportunities.

ACKNOWLEDGMENTS

The authors gratefully thanks the US-Egypt Science and Technology Program; Joint Research Grant for financial support. A special thank to the Mechanical Power Department in the Faculty of Engineering, Zagazig University for kindly providing the facilities and extending necessary help to conduct the engine tests of the fuels and various blends under study, specially Pr. Dr. Hafez Abdel Aal El- Salmawy for his mechanical advices.

REFERENCES

- [1] Kloptenstem WE. Effect of molecular weights of fatty esters on cetane numbers as diesel fuels, *J. Am. Oil Chem. Soc.* 65 (1988) 1029-31.
- [2] Harington KJ. Chemical and physical properties of vegetable oil esters and their effect on diesel fuel performance, *Biomass* 9(1986)1-17.
- [3] Masjuki H, Salit. Biofuel as diesel fuel alternative: an overview, *J. Energy Heat Mass Transfer* 15 (1993)293-304.
- [4] LePori WA, Engler CR, Johnson LA, Yarbrough CM. Animal fats as alternative diesel fuels, in liquid fuels from renewable resources, *Proceedings of an Alternative Energy Conference, American Society of Agricultural Engineers, St Joseph* (1992)89-98.
- [5] Srinivasa RP, Gopalakrishnan VK. Vegetable oils and their methylesters as fuel for diesel engines, *Ind. J. Technol.*(1991) 29:292-7.
- [6] Hawash SI, Kamal N and El Diwani G. Egyptian Jatropha oil extraction for biodiesel production, *AFINIDAD* (2008) LXV, 536.
- [7] Amin S.K., Hawash S.I., El Diwani G., El.Rafei S., kinetic and thermodynamics of oil extraction from Jatropha Curcas in aqueous acidic hexane solution, *Journal of American Science*(2010) 6 (11):293 -300.
- [8] Masjuki H, Sohif M., Performance evaluation of palm oil diesel blends on small engine,*J. Energy Heat Mass Transfer*(1991) 13:125-33.
- [9] Nag A, de Bhattacharya KB. New utilization of vegetable oils, *J. Am. Oil Chem. Soc.* (1996)71(4):471-7.
- [10] Takeda Y. Developmental study on jatropha curcas (Sabu dum) oil as a substitute for diesel engine oil in Thailand, *J. Agricultural ASSOC. China* (1982) 20:1-9.
- [11] Piyaporn K, Narumon J, Kanit K., Survey of seed oils for use as diesel fuels, *J. Am. Oil Chem Soc.* (1996) 71(4)L:471-7.
- [12] Agarwal A.K., Vegetable oils verses diesel fuel: development and use of biodiesel in a compression ignition engine, *TIDE* (1998) 8(3) 191-204.
- [13] Sinha S., Misra N.C., Diesel fuel alternative from vegetable oils, *Chem. Eng. World* (1997) 32(10) 77-80.
- [14] Roger A.K., Jaiduk J.O., A rapid engine test to measure injector fouling in diesel engines using

- vegetable oil fuels, *J. Am. Oil Chem. Soc.*(1985) 62(11) 1563-4.
- [15] Ryn TW, Dodge LG, Callahan TJ. The effects of vegetable oil properties on injection and combustion in two different diesel engines, *J. Am. Oil Chem. Soc.* (1984) 61(10) 1610-9.
- [16] Rewolinski C, Shaffer DL. Sunflower oil diesel fuel: Inbrication system contamination, *J. Am. Oil Chem. Soc.* (1085)61(7) 1120-4.
- [17] Ziejewski M., Kaufman K.R., Laboratory endurance test of a sunflower oil blend in a diesel engine, *J. Am. Oil Chem. Soc.*(1983)60(8) 1567-73.
- [18] Pryde E.H., Vegetable oil as diesel fuels: overview, Papers from symposium on vegetable oils as diesel fuels, Presented at the 73rd AOCS annual meeting, Toronto, Canada *J. Am. Oil Chem. Soc.* (1983) 60(8).
- [19] Ramadhs A.S., Jayaraj S., Muraleedharan C., Use of vegetable oils as C.I. engine fuel – A review, *Renewable Energy* (2004) 29 pp 727-742.
- [20] Krzysztof G., Ruslans S., Impact of ether/ethanol and biodiesel blends on combustion process of compression ignition engine, *Engineering for Rural Developemnt Jelgaw* (2011) 26-27.
- [21] El Diwani G, Hawash S.I. and Kamal N., Development and evaluation of biodiesel fuel and byproducts from *Jatropha* oil, *IJEST, Int. Journal of Environmental Science and Technology* (2009) Vol 6, No 2 pp 219 – 224.
- [22] Hawash S.I., El Diwani G., Abdel Kader E. Optimization of biodiesel production from *Jatropha* oil by heterogeneous base catalyzed transesterification, *International Journal of Engineering Science and Technology (IJEST)* (2011) 3(6) pp5242-5251.
- [23] Tzillah, Aisha. The emissions of criteria air pollutants from biodiesel fuel usage, MSc, University of Cincinnati, Engineering: Environmental Engineering (2009).
- [24] Luis MV, Rui MO, Camara, Vasso JR Caeira, Gamerio da Silva MS. Performance study about biodiesel impact on buses engines using dynamometer tests and fleet consumption data, *Energy Conversion and Management*(2005).
- [25] Leon G. Schumcher. Biodiesel emissions data from series 60 DDC engines, Bus operations and Technology Conference, Reno, Nevada May 10(1995).
- [26] El Diwani G., et al., Biodiesel fuel from non edible vegetable oils, Annual progress Report NRC. Egypt March (2006).
- [27] El-Salmawy HAA. et al, Biodiesel and its use in compression ignition engine, Graduation project-report. Faculty of Engineering – Zagazig University. Egypt (2007).
- [28] El Diwani G., El Rafie S., Modification of thermal and oxidative properties of biodiesel produced from vegetable oils, *International Journal of Environmental Science and Technology(IJEST)* (2008) 5(3).
- [29] Tsolakis A., Effect on particle size distribution from the diesel engine operating on RME- biodiesel with EGR, *Energy Fuels*(2006) 10,1021/ef050385c.
- [30] Senatore A, Cardone M, Rocco V, Prati MV. A comparative analysis of combustion process in D.I. Diesel engine fueled with biodiesel and diesel fuel, SAE paper(2000) 2000-01-0691.
- [31] Shaheed A, Swain E. Combustion analysis of coconut oil and its methyl esters in a diesel engine, *Porc I MECH E Part A J Power Energy* (1999)213/5 pp 417-425.
- [32] Gaboski MS, Ross JD, McCormick RL. Transient emissions from no.2 diesel and biodiesel blends in a DDC series 60 engine, SAE paper(1996) 961166.
- [33] Canakci M. Performance and emissions characteristics of biodiesel from soybean oil, *Proc I MECH E Part D J Automob Eng.* (2005) D7 pp 915 - 922.
- [34] Kaplan C, Arslin R, Surmen A, A. Performance characteristics of sunflower methyl esters as biodiesel, *Energy Sources*(2006) Part A28 pp751- 755.
- [35] Agarwal AK, Ds LM. Biodiesel development and characterization for use as a fuel compression in ignition engines, *Trans ASME J Eng Gas Turbine Power* (2001) 123 pp 440- 447.
- [36] Zheng M, Mulenga MC, Reader GT, Wang M, Ting DSK, Tjong J. Biodiesel engine performance and emissions in low temperature combustion. *Fuel* 2008;87(6):714–22.

- [37] Deshmukh SJ, Bhuyar LB. Transesterified Hingab (Balanies) oil as a fuel for compression ignition engines, *Biomass and Bioenergy* (2009) 33 pp108-112.
- [38] Pinto AC, Guaieiro LLN, Rezende MJC, Ribeiro NM, Torres EA, Lopes WA, de Pereira PA, de Andrade JB. Biodiesel: an overview, *J. Braz Chem. Soc.* (2005) 16/6B pp 1313-1330.
- [39] Serdari A, Fragioudakis K, Teas C, Zannikos F, Stournas S, Lois E. Effect of biodiesel addition to diesel fuel on engine performance and emissions, *J. Propul Power* (1999) 15/2 pp 224- 231.
- [40] Biodiesel from Frontier Energy, <http://www.frontieerenergy.org/biodiesel.htm>

IJSER